



DISTRIBUTEUR EXCLUSIF FRANCE
FABRICATION EN SUÈDE



Butée de rail



rainurage sol

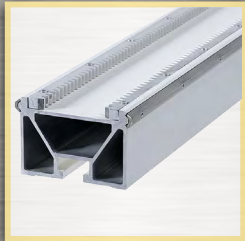

support carter parallèle



plaque de liaison

GUIDE DE POSITIONNEMENT DES SABOTS POUR LE SCIAGE MURAL

Pentrunder[®]
CONCRETE CUTTING SYSTEMS

Sabot Pivotant

- Déplacement du rail à 90° sans ôter la tête de rail
- Gain de temps
- Evite de porter la scie manuellement
- Evite les risques de chute et les erreurs de manipulation

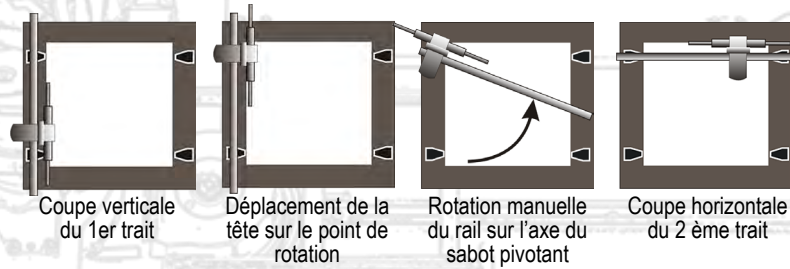

Guide

- Guide de positionnement des sabots
- Gain de temps
- Positionnement rapide et exact des sabots sans report de mesures

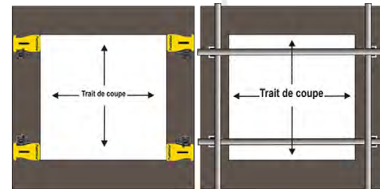

Double guide



Tél : +352 28 48 01 40
Email : contact@diatom.lu

www.diatom.lu

